

# VENTILATION DUCT HEATER SECTION 10 DESIGN / Mechanical

**Figure 24**

Valad Vent Duct Heaters are available in two basic designs:

Insert (Figure 23) and Frame (Figure 24).

**Figure 23  
FRAME**

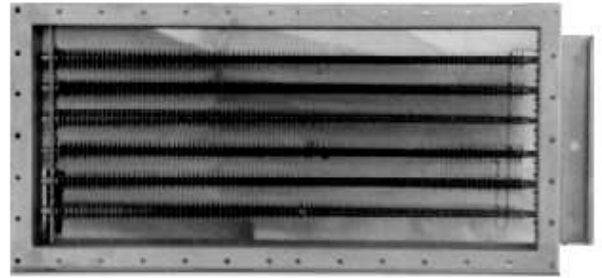

**SIZING TERMINOLOGY:**

Length - Width - Depth

Example: **VDH 12 X 8 -1**

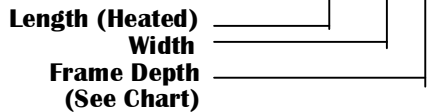

- Depth Chart**
- 1 = 5.75
  - 2 = 11.50
  - 3 = 15.50

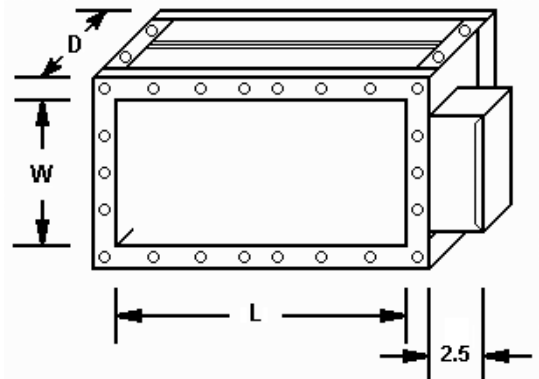

**NOTE A:**

Length dimension always on same plane as terminal box.

**NOTE B:**

Dimensions are always I.D. Dimensions add 3" to overall to get O.D. Dimensions.

**MOUNTING:**

**FRAME TYPE:**

13/32" Dia. holes are provided on a 3" center to center dimension. Balance of holes are reduced to 2" center to center (See Figure 26).

**INSERT TYPE:**

Mounting holes are provided on mounting plate. Customer uses plate for hole pattern (See Figure 27) to mount unit to duct. Hole patterns will vary according to size.

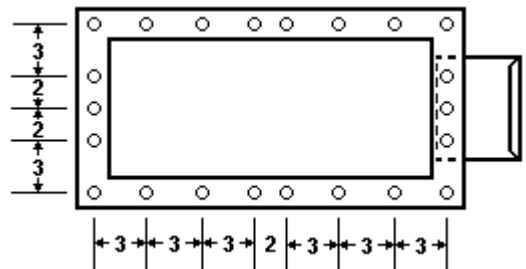

TYPICAL EXAMPLE -HOLES MAY VARY TO SUIT UNIT

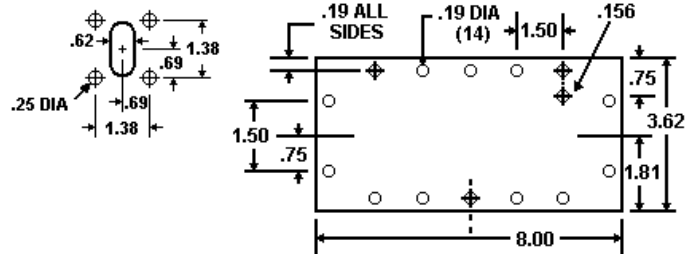

**FRAME**



**ELECTRIC HEATING CORP.**

160 WILDEY STREET  
TARRYTOWN, N.Y. 10591 U.S.A.  
(914) 631-4927 FAX: (914) 631-4395

# VENTILATION DUCT HEATER SECTION 10

## VELOCITY

Valad's Vent Duct Heaters are equipped with a manual or auto reset safety overload thermostat. A minimum velocity should be maintained to prevent thermostat tripping. (See sample one for calculation.)

**Sample One:** Duct heater size 18 length x 16 width  
Wattage=10000W calculate wattage per square foot of duct area.  
Re: 18"=1.5 ft 16"=1.3 ft

$$\frac{\text{Wattage}}{\text{Length} \times \text{Width(ft)}} = \frac{10000}{1.5 \times 1.3} = \frac{10000}{1.95} = 5128 \text{ W/sq. ft.}$$

Refer to Valad's Air Flow Chart A/minimum air required is 350 FPM. It is necessary to convert to CFM at this point:  
350 x Total Duct Area (1.5 x 1.3) = (350 x 1.95) = 682.5 CFM

## KILOWATT REQUIREMENTS

KW Requirements (See Chart B for KW load.)

**Note:** This chart is only a suggested KW load chart. Valad Electric will not be held liable for non-performance on values obtained from this chart.

## PRESSURE DROP

Valad's heater design provides excellent resistance to air flow values. (See Chart C for values.)

CHART C - Fig.30  
Pressure Drop

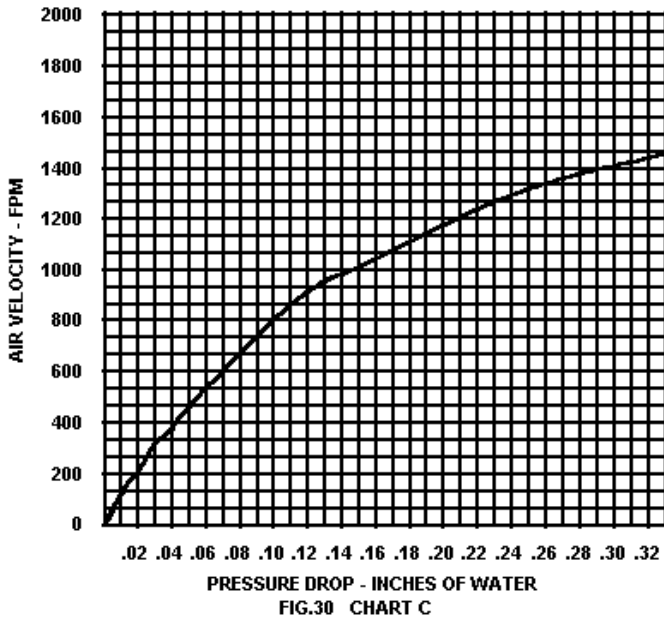

CHART A - FIG. 28  
AIR FLOW CHART

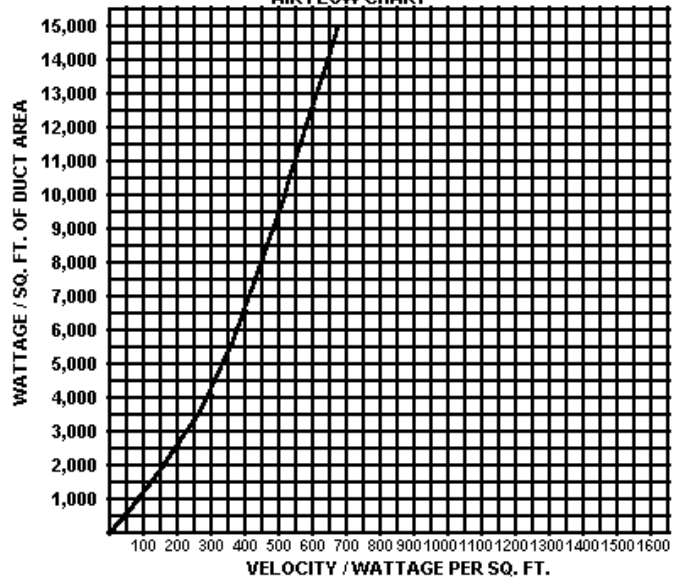
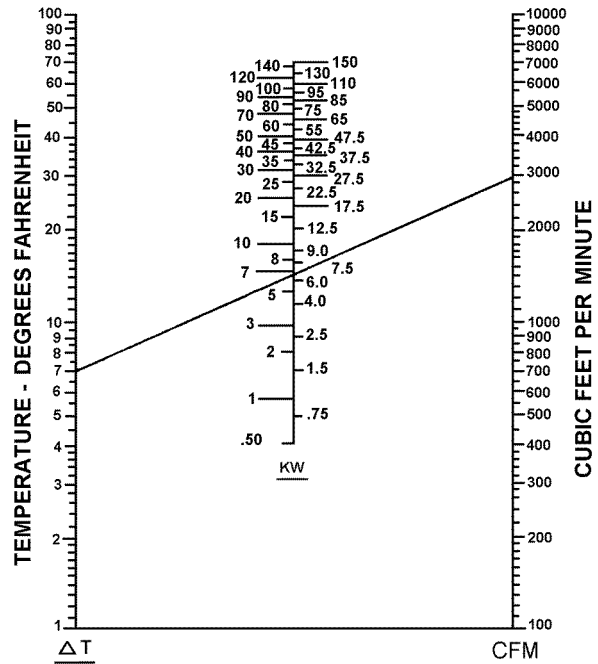

FIG. 28 CHART A



**SAMPLE:** To find the KW needed to raise 3000CFM through a temperature rise of 7 deg F on the Delta Scale and 3000 on the CFM Scale with a straight line. The intersect of this line with the KW Scale will indicate the required KW.

KILOWATTS REQUIRED  
FIG.29 - CHART B



**ELECTRIC HEATING CORP.**  
160 WILDEY STREET  
TARRYTOWN, N.Y. 10591 U.S.A.  
(914) 631-4927 FAX: (914) 631-4395